

1 SIDE VIEW
1" = 1'-0"

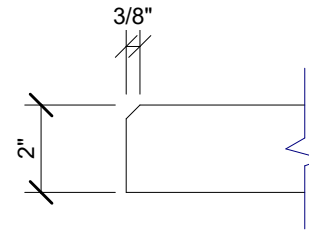

2 EDGE DETAIL
3" = 1'-0"

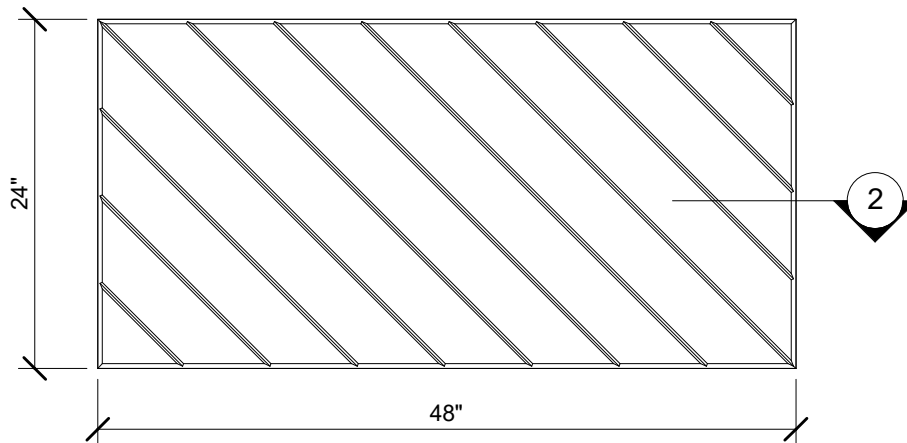

3 PLAN VIEW
1" = 1'-0"

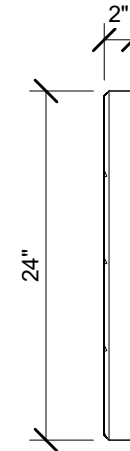

4 END VIEW
1" = 1'-0"



123 Columbia Court N. Chaska, MN 55318
www.acousticalsurfaces.com
1-800-854-2948

PRODUCT LINE: 2" Enviroacoustic Design Panels - 2ft x 4ft - Beveled Edge - Uphill

PRINT DATE: 01/23/26

DRAFTER: ASI

Note:
These drawings are provided for general reference and to illustrate product features and conditions. They are not intended for construction, fabrication, or installation. Do not scale drawing.

COPYRIGHT ASI © 2025

SHEET NUMBER:

A101